



**Out of this world savings.**

---

## **User Manual**

Model: **4741, 5134**

---

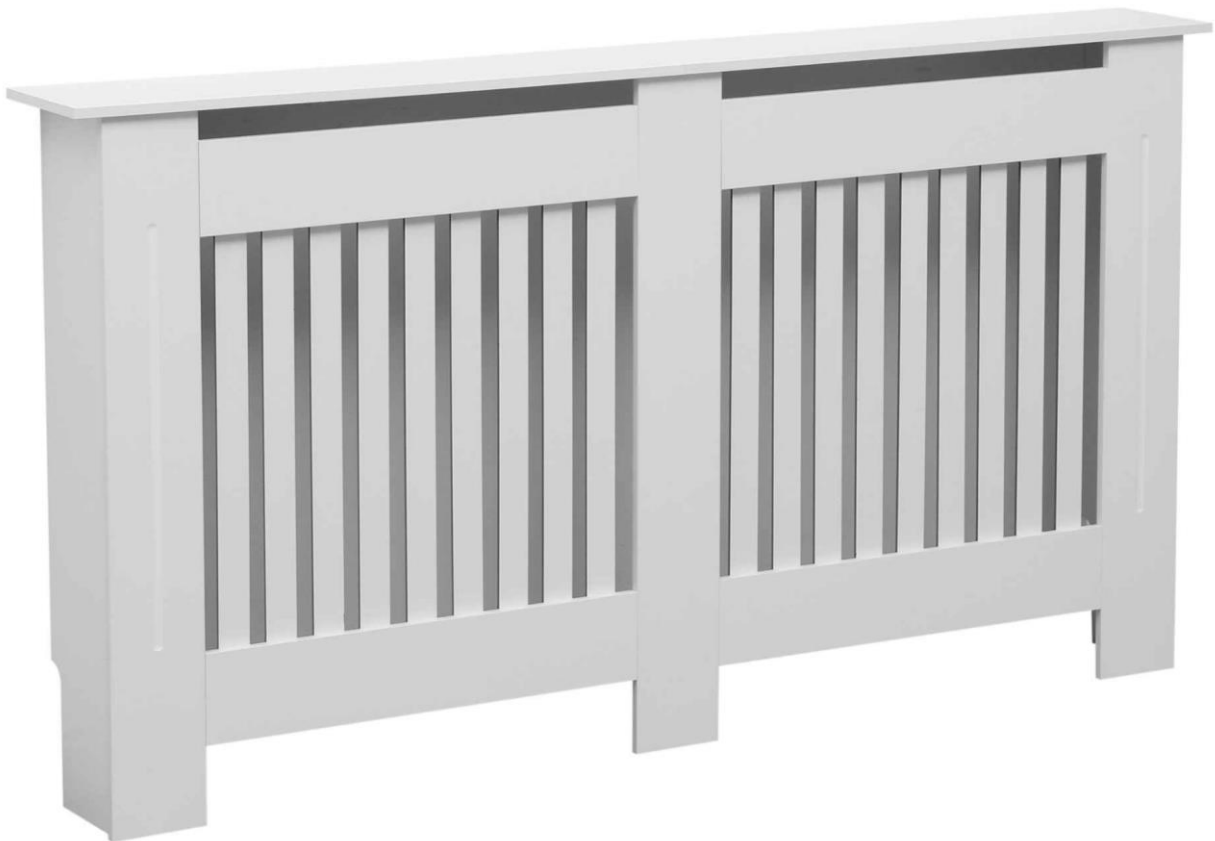

# **Radiator Cover (Large)**

*\*Colour May Vary*

---

---

# Contents

Safety Information .....	2
What's In The Box?.....	3
Assembly Instructions.....	4

---

## Safety Information

### Please ensure you read and fully understand instructions before use

While every attempt is made to ensure the highest degree of protection in all equipment, we cannot guarantee freedom from injury. The user assumes all risk of injury due to use. All merchandise is sold on this condition, which no representative of the company can waive or change.

---







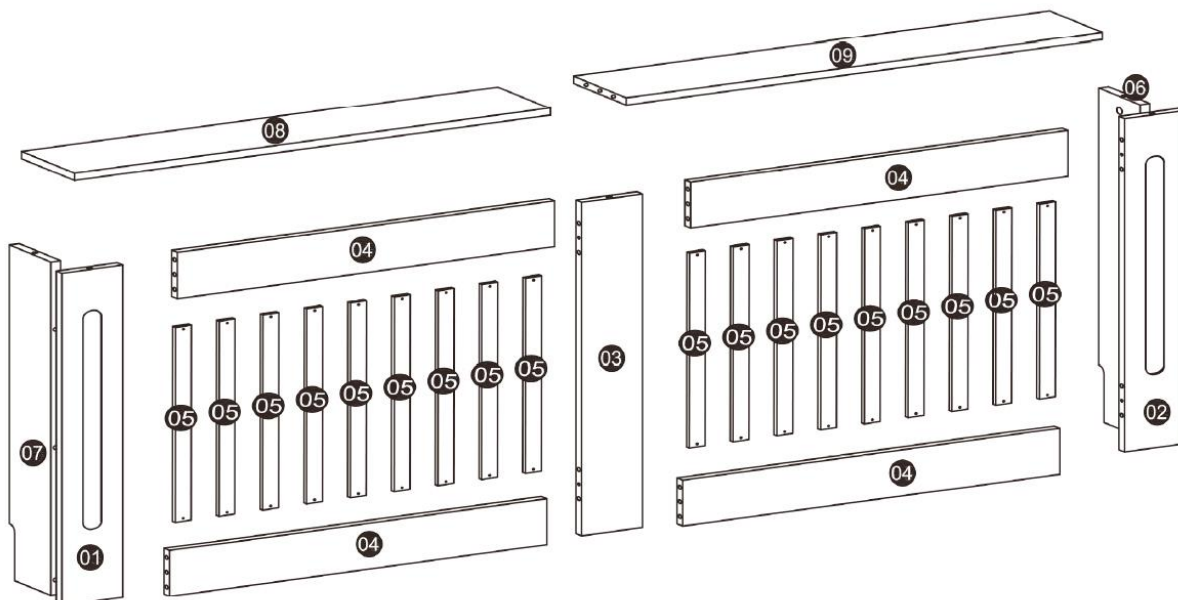

- Never carry out any alterations or modifications to this product.
  - This product is not a toy, and is only to be used for its designated purpose.
  - This product is intended for outdoor use only.
  - Keep fingers, loose clothing, and hair away when assembling the product
  - Make sure all fastenings are tightly in place and that everything is in order before using the product. This should be checked periodically by an adult.
  - This product contains small parts that could be a choking hazard if swallowed. Keep these items away from children.
  - Do not sit or stand on the radiator cover as this may lead to personal injury and product failure.
  - Various part of the assembly might be easier with 2 people.
  - If you are unsure on how to assemble, then contact a professional expert to help.
  - Keep away from fire.
  - Dispose of all packaging carefully and responsibly.
  - Clean only with a damp cloth. Do not use abrasive or industrial cleaning substances. Doing so may damage the product.
  - Regularly check that all screws are tightly attached and nothing is loose.
  - If the product is damaged or has any defects, do not use and please contact [cservice@oypla.com](mailto:cservice@oypla.com)
-

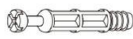
# What's In The Box?

Please note that you will be referring to the below parts list during assembly

If any of the below parts are missing or damaged, please contact our dedicated team at [cservice@oypla.com](mailto:cservice@oypla.com).

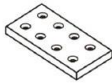

<p>(A) CAM lock dowel x20</p> 	<p>(B) CAM lock x20</p> 	<p>(C) Wood dowel x16</p> 	<p>(D) Screw x44</p> 
<p>(E) Screw x4</p> 	<p>(F) Wall anchor x4</p> 	<p>(G) Wood block x2</p> 	<p>(H) Wood dowel x3</p> 
<p>(I) Iron sheet x1</p> 			

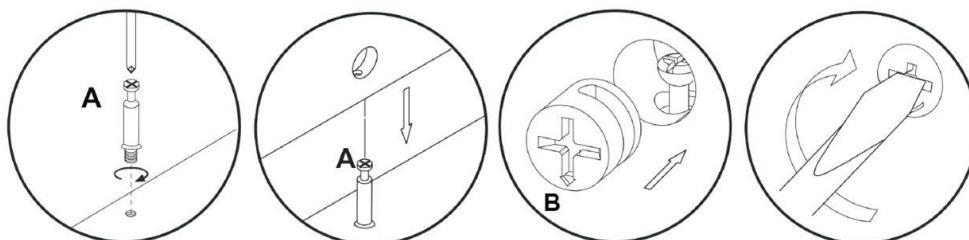
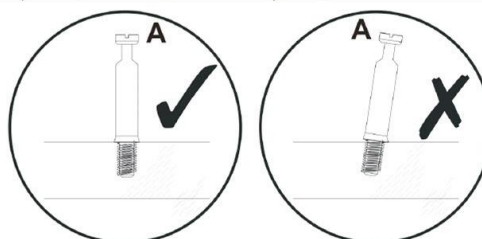

# Assembly Instructions

Please refer to the below information to help assemble your Oypla product

If you require assistance with the assembly of your Oypla product, please contact our dedicated team at [cservice@oypla.com](mailto:cservice@oypla.com).

## Step 1

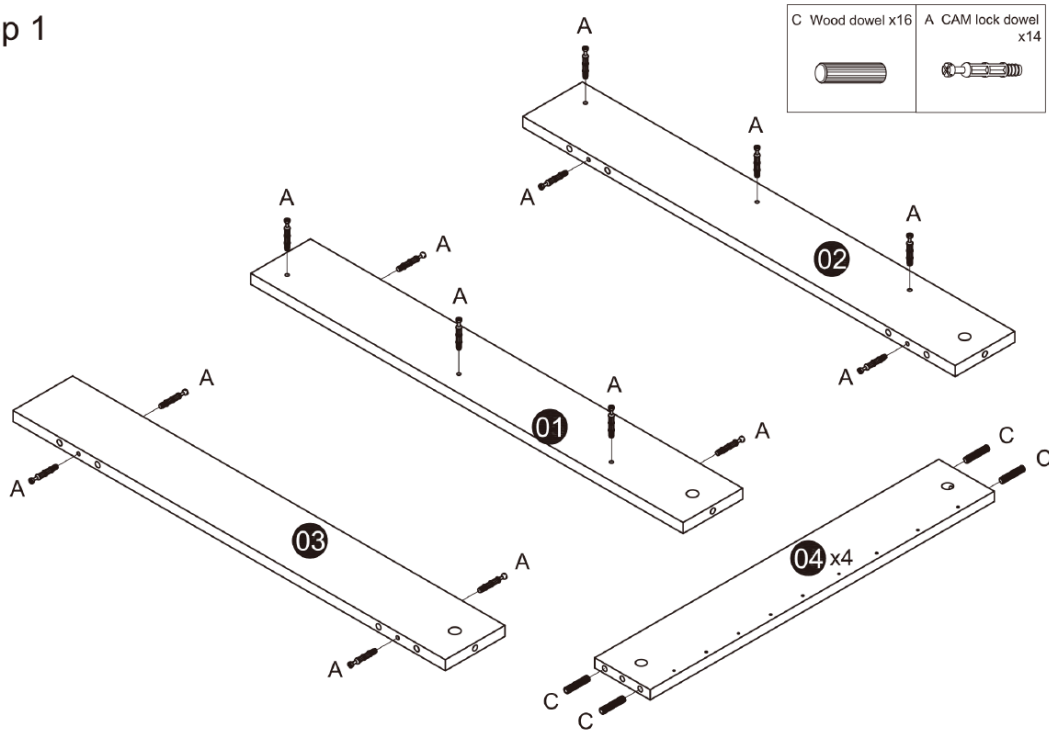

## Step 2

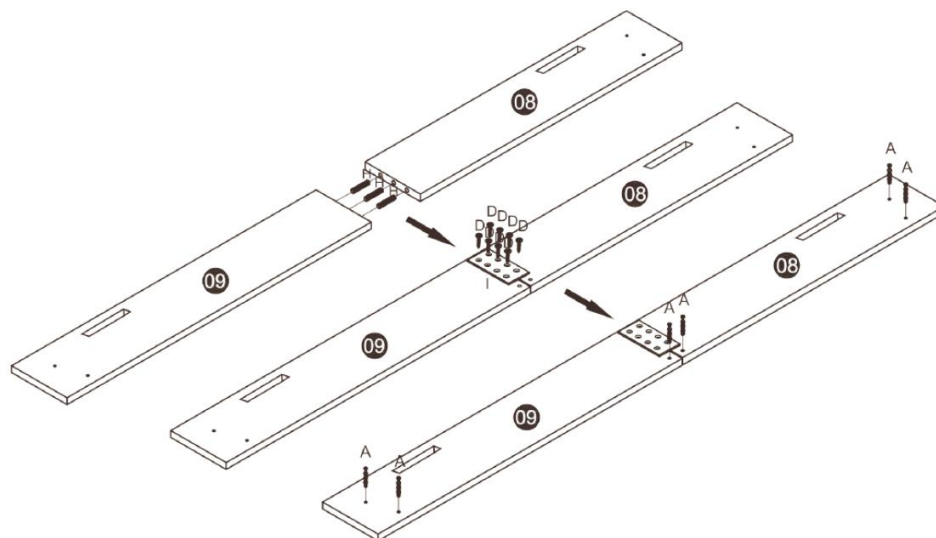
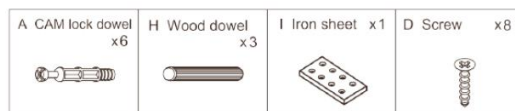

Step 3

B CAM lock x4

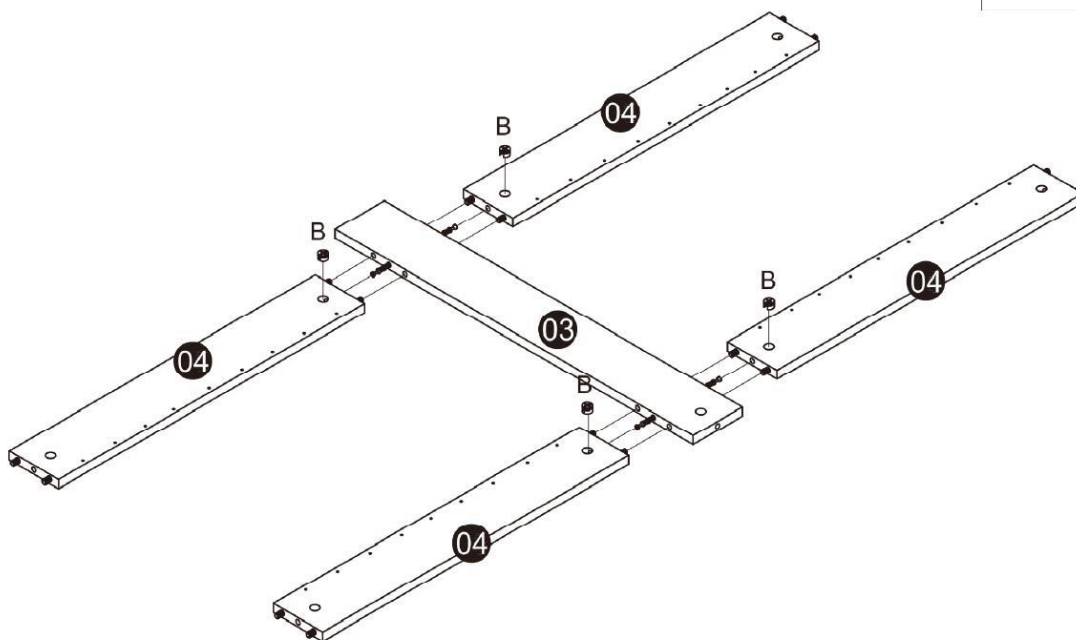

Step 4

B CAM lock x4

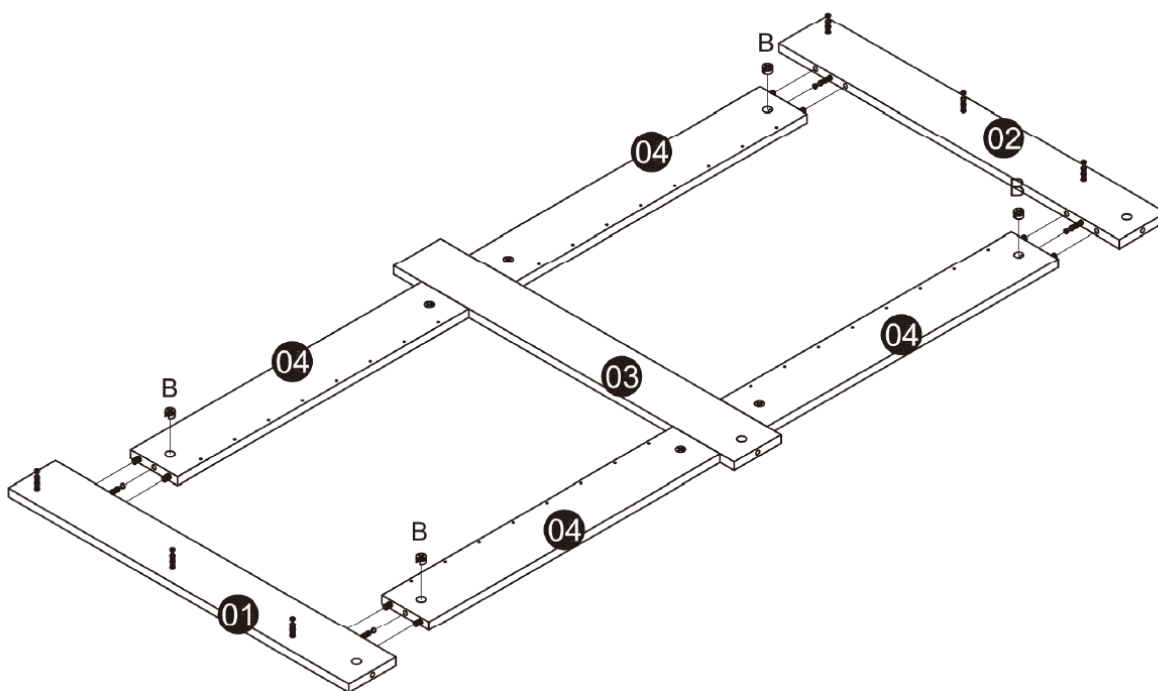

Step 5

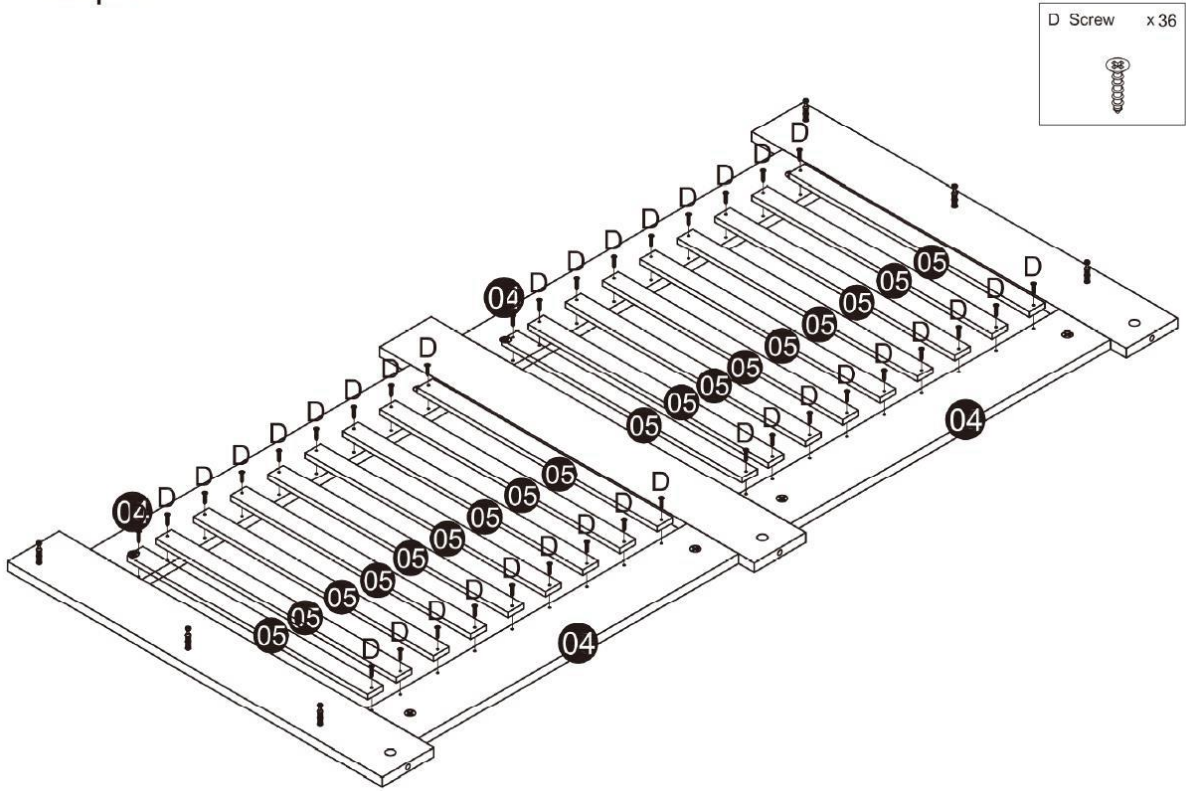

Step 6

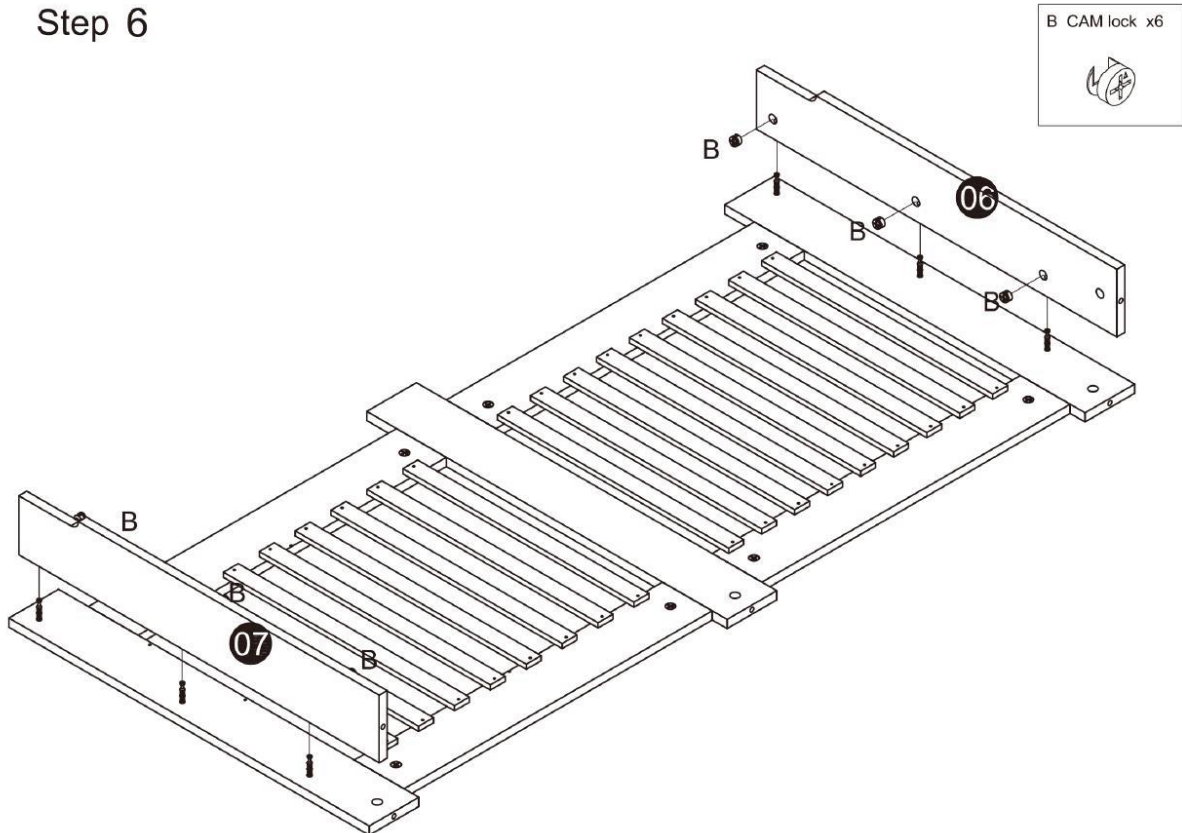

Step 7

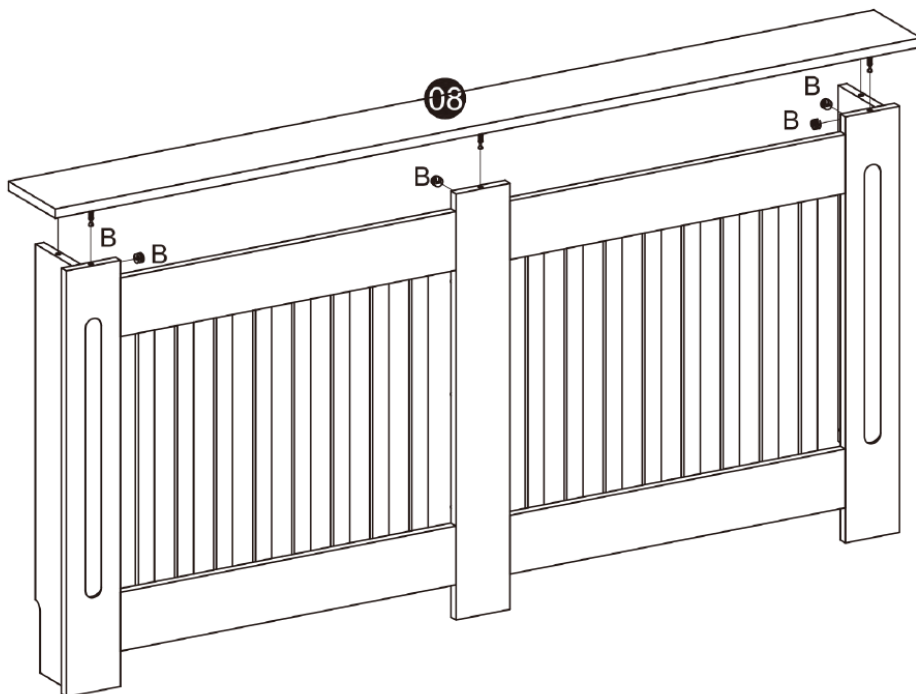
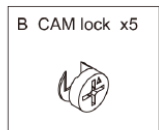

Step 8

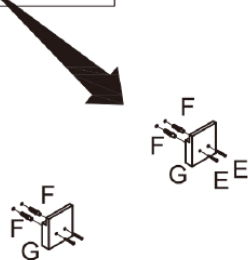
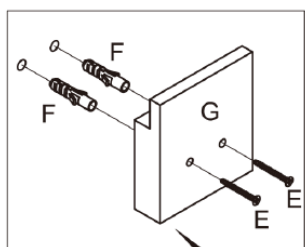

---

## Step 9

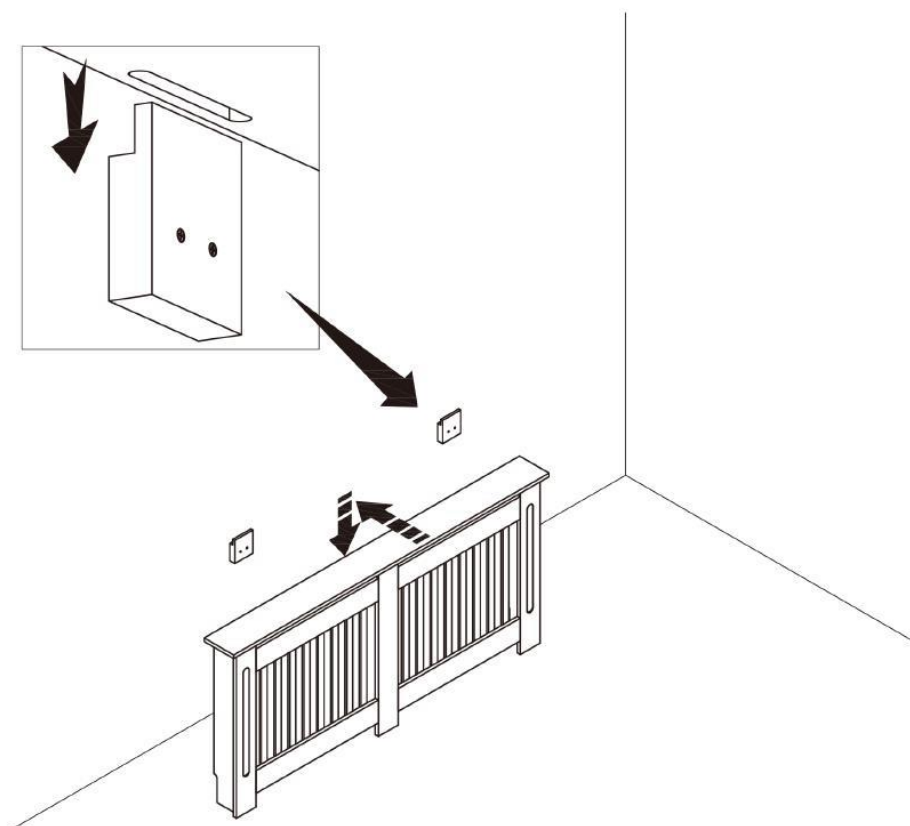

---

## Have a Question About Your Purchase?

Our dedicated customer services team are happy to help. Contact them via:

Telephone: 020 3600 22 55  
Email: [cservice@oypla.com](mailto:cservice@oypla.com)  
Live Chat: [www.oypla.com](http://www.oypla.com)

---

## Consider the Environment!

By recycling the cardboard box in which this product was packed, you contribute towards helping the environment. If you see a recycling logo such as the below on the packaging, it can be recycled. If a recycling logo is not present, please check with your local authority before recycling.



---

**PLEASE RETAIN A COPY OF THESE INSTRUCTIONS FOR FUTURE CONSULTATION**

An Official Oypla Branded Product

Imported by Oypla.com LLP, Uxbridge, UB8 2FX

**User Manual**

Model Code: 4741, 5134

[Oypla.com](http://Oypla.com) LLP / [cservice@oypla.com](mailto:cservice@oypla.com)