

HOME

Model Code: 4688,4105

THANK YOU FOR YOUR ORDER

Contents

- 1 Front Cover
-
- 2 Safety
Instructions
-
- 3 Assembly
Instructions
-
- 4 Back Cover

End



COLOUR MAY VARY

10 Drawer Storage Trolley

Contents

1	Front Cover
-	
2	Safety Instructions
-	
3	Assembly Instructions
-	
4	Back Cover
	End

Safety Instructions

Notice: Ensure you read and fully understand instructions before use

While every attempt is made to ensure the highest degree of protection in all equipment, we cannot guarantee freedom from injury. The user assumes all risk of injury due to use. All merchandise is sold on this condition, which no representative of the company can waive or change.

- This product contains small parts that could be a choking hazard if swallowed. Keep these items away from children.
- Make sure all fastenings are tightly in place and that everything is in order before using the product. This should be checked periodically by an adult.
- This product is intended for indoor use only.
- This product is not a toy, and is only to be used for its designated purpose.
- Do not carry out alterations or modifications to this product.
- Leaving the product outside exposed to weather, especially direct sun and rain, will speed the weathering process. This can be slowed by removing the product from these conditions, or covering it with a suitable cover.
- Only use this product on stable, level and dry ground.
- The maximum weight of this product is 15kg. Do not exceed this amount.
- This product is for domestic use only.
- Ensure the product is fully secure before putting anything into the drawers.
- Do not discard any of the packaging until you have checked that you have all the parts and fittings required.
- Do not lean or support any heavy objects on the product to avoid product damage.
- Clean only with a damp cloth. Do not use strong industrial cleaning substances
- If the product is damaged or has any defects, please contact cservice@oypla.com.

Warnings

⚠ The maximum weight of this product is 15kg. Do not exceed this amount. This could lead to product failure and/or personal failure.

⚠ This product contains small parts that could be a choking hazard if swallowed. Keep these items away from children.

Contents









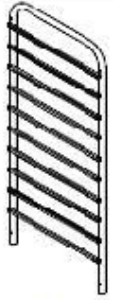

- 1 Front Cover
-
- 2 Safety Instructions
-
- 3 Assembly Instructions
-
- 4 Back Cover

End

Assembly Instructions

Parts List:

- If you are missing any of the below parts, please contact cservice@oypla.com
- Please be aware that you will be referring to this parts list throughout the assembly process.

					
A x 2	B x 1	D x 4	F x 4	H x 10	J x 1
					
	C x 10	E x 8	G x 4	I x 10	

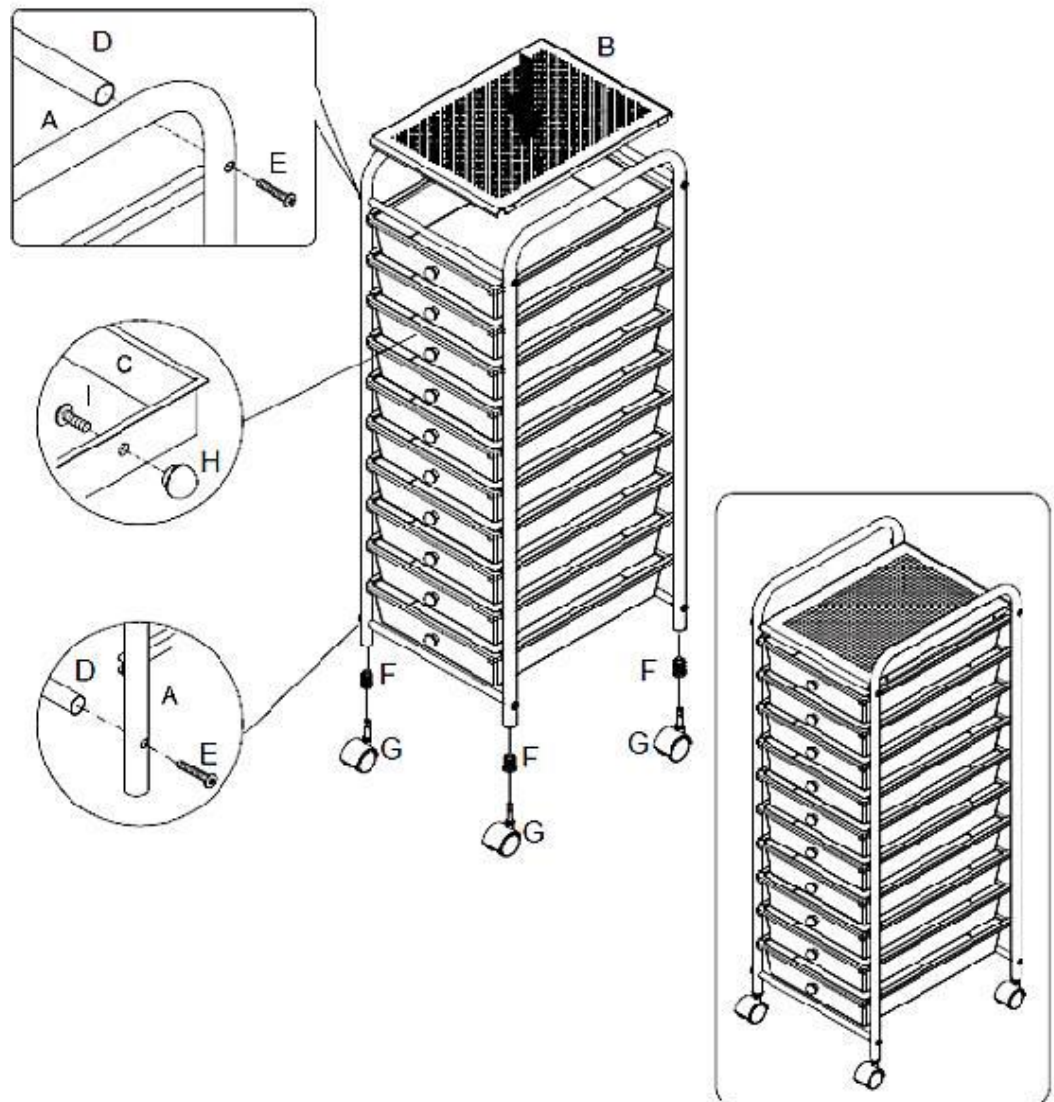

Model Code: 4105.4688

Oypla.com LLP / www.oypla.com

Contents

- 1 Front Cover
-
- 2 Safety
Instructions
-
- 3 Assembly
Instructions
-
- 4 Back Cover

End

HAVE A QUESTION ABOUT YOUR PURCHASE?

Our dedicated customer services team are happy to help. Contact them via:

Telephone: 020 3600 22 55
Email: cservice@oypla.com
Live Chat: WWW.OYPLA.COM

CONSIDER THE ENVIRONMENT!

In the United Kingdom, approximately 5 billion corrugated boxes are used per year, amounting to around 83 per person! By recycling the cardboard box in which this product was packed, you contribute to the preservation and sustainability of the environment.

If you see a recycling logo on the packaging of your product, such as the below examples, that piece of packaging is recyclable. If there is not a recycling logo, please check with your local authorities before recycling.



PLEASE RETAIN A COPY OF THESE INSTRUCTIONS FOR FUTURE CONSULTATION

OYPLA.COM

AN OFFICIAL OYPLA BRANDED PRODUCT