

LEISURE

THANK YOU FOR YOUR ORDER

Contents

- 1 **Front Cover**
-
- 2 **Safety Instructions**
-
- 3 **Assembly Instructions**
-
- 4 **Back Cover**

End



*1 Supplied

Double Bike Rack

Contents

1	Front Cover
-	
2	Safety Instructions
-	
3	Assembly Instructions
-	
4	Back Cover

End

Safety Instructions

Notice: Ensure you read and fully understand instructions before use

While every attempt is made to ensure the highest degree of protection in all equipment, we cannot guarantee freedom from injury. The user assumes all risk of injury due to use. All merchandise is sold on this condition, which no representative of the company can waive or change.

- Make sure all fastenings are tightly in place and that everything is in order before using the product. This should be checked periodically by an adult.
- Do not discard any of the packaging until you have checked that you have all of the parts and fittings required.
- Use the correct fixings as indicated. Do not tighten any of the nuts until the unit is completely assembled, then finish by tightening all nuts. All nuts must be tightened before use.
- Do not carry out alterations or modifications to this product.
- Persons (including children) with reduced physical, sensory and mental capacities or lack of experience and knowledge do not intend this product for use, unless persons responsible for their safety have given them supervision or instruction concerning use of the product.
- Ensure product is placed on a firm, level and dry ground.
- If the product is damaged or has any defects, please contact cservice@oypla.com

Contents

- 1 Front Cover
-
- 2 Safety Instructions
-
- 3 **Assembly Instructions**
-
- 4 Back Cover











End

Assembly Instructions

Parts List:

If you are missing any of the below parts, please contact cservice@oypla.com

Please be aware that you will be referring to this parts list throughout the assembly process.

Accessory	No.	Q'ty
	part#1	1
	part#2	2
	part#3	2
	part#4	4
	part#5	1
	HH	2
	CW	2
	A	6
	B	8
	Allen wrench	1
	Box wrench	1

Contents

1

- 1 Front Cover
-
- 2 Safety Instructions
-
- 3 **Assembly Instructions**
-
- 4 **Back Cover**

End

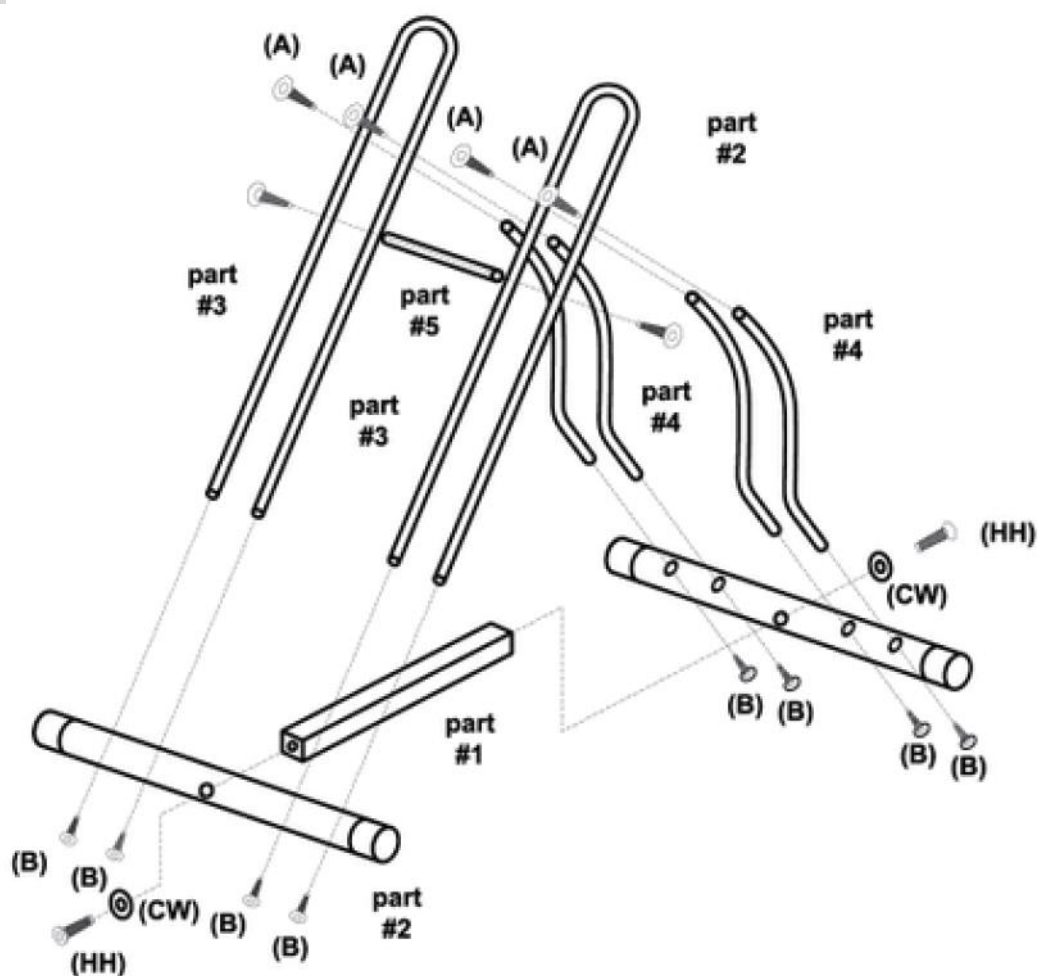

HAVE A QUESTION ABOUT YOUR PURCHASE?

Our dedicated customer services team are happy to help.

- Telephone: 020 3600 22 55
- Email: cservice@oypla.com
- Live Chat: www.oypla.com

PLEASE RETAIN A COPY OF THESE INSTRUCTIONS FOR FUTURE CONSULTATION

OYPLA.COM

An Official OYPLA Branded Product