



# Wooden Storage Chest

# Safety Instructions

**Notice: Ensure you read and fully understand instructions before use**

While every attempt is made to ensure the highest degree of protection in all equipment, we cannot guarantee freedom from injury. The user assumes all risk of injury due to use. All merchandise is sold on this condition, which no representative of the company can waive or change.

- Make sure all fastenings are tightly in place and that everything is in order before using the product. This should be checked periodically by an adult.
- This product is not a toy, and is only to be used for its designated purpose.
- This product is intended for indoor use only. Leaving the product outside exposed to weather, especially direct sun and rain, will speed the weathering process. This can be slowed by removing the product from these conditions.
- Do not carry out alterations or modifications to this product.
- Clean only with a damp cloth. Do not use abrasive cleaners or detergents.
- Do not discard any of the packaging until you have checked that you have all of the parts and fittings required.
- Keep fingers, loose clothing, and hair away when closing the lid of the product. Pinch points can cause personal injury.
- This product contains small parts that could be a choking hazard if swallowed. Keep these items away from children.
- Use the correct fixings as indicated. Do not tighten any of the nuts until the unit is completely assembled, then finish by tightening all nuts. All nuts must be tightened before use.
- Keep away from fire.
- If the product is damaged or has any defects, please contact [cservice@oypla.com](mailto:cservice@oypla.com)





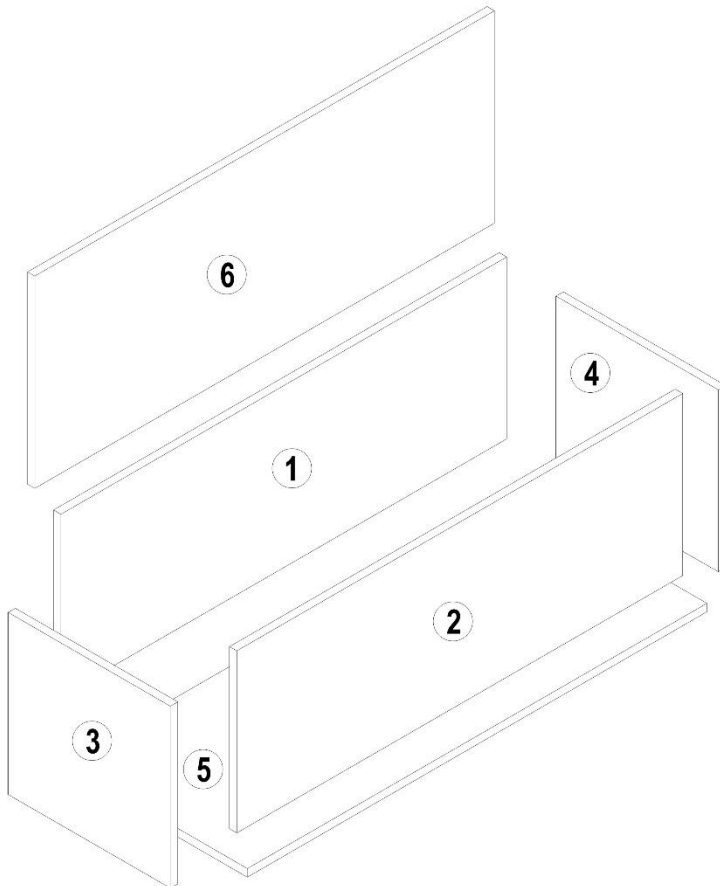

# Operating Instructions

## Parts List:

If you are missing any of the below parts please contact [cservice@oypla.com](mailto:cservice@oypla.com)

Please be aware that you will be referring to this parts list throughout the assembly process.

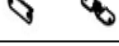

NO.	QTY.	LINEDRAWING	DESCRIPTION
A	28		Bolt
B	3		Hinge
C	4		Foot
D	4		Foot Screw
E	22		Screw
F	1		Lid Prop
G	2		Lid Prop Brackets
1	1		Back
2	1		Front
3	1		Left Side
4	1		Right Side
5	1		Base
6	1		Lid

1. Attach the sides (3, 4) to the back panel (1) using three bolts each (A).
2. Attach the front panel (2) to the sides (3, 4) using three bolts each (A).
3. Attach the base (5) to the assembled frame using sixteen bolts (A).
4. Attach the feet (C) to each corner of the base using a long screw on each (D).
5. Attach the three hinges (B) along the underside of the lid (6) using two short screws each (E).
6. Attach the lid to the back of the chest by securing each hinge with four screws (E).
7. Attach the brackets (G) onto the lid and right panel by using two screws (E) for each bracket, using the lid prop to guide which bracket to use. Attach the lid prop (F) onto the lid and the right side panel, ensuring that the middle arm is connected to the lid and the far right arm is connected to the right panel.

1

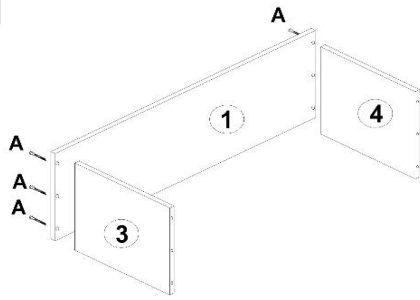

2

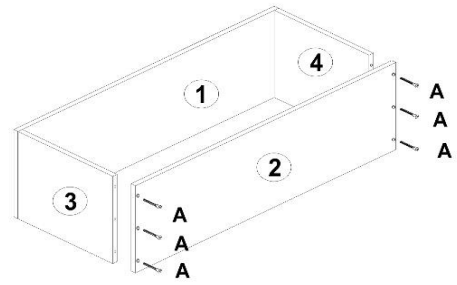

3

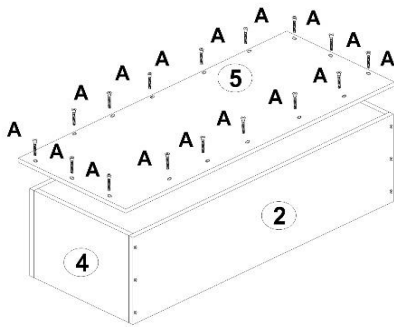

4

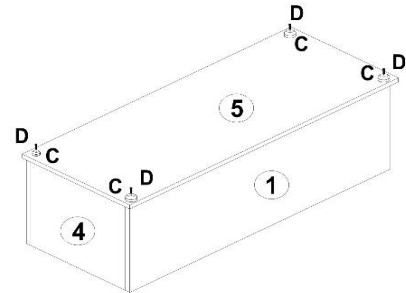

5

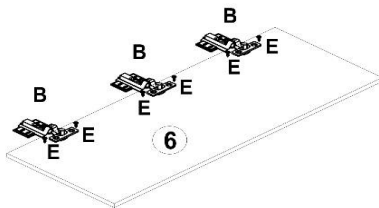

6

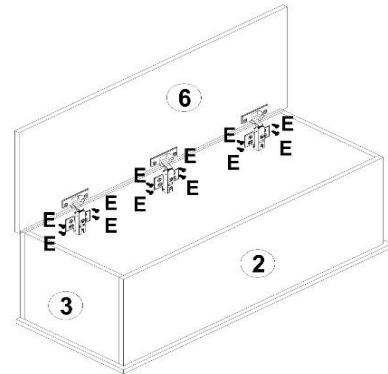

7

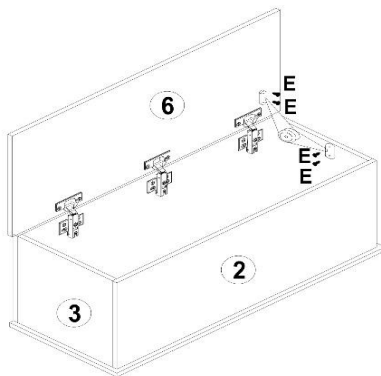

8

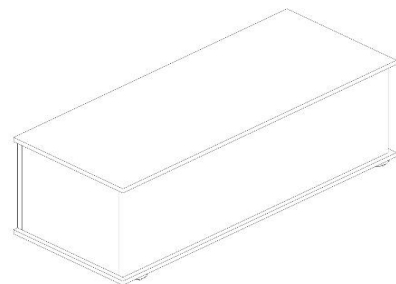

Please retain a copy of all instructions for future consultation.



An Official Oypla Branded Product

Imported into the EU by Oypla.com LLP, Uxbridge, UB8 2FX

USER MANUAL Model No: 4206, 4207