



Double Aluminium Cold Frame

Safety Instructions

Notice: Ensure you read and fully understand instructions before use

While every attempt is made to ensure the highest degree of protection in all equipment, we cannot guarantee freedom from injury. The user assumes all risk of injury due to use. All merchandise is sold on this condition, which no representative of the company can waive or change.









- Make sure all fastenings are tightly in place and that everything is in order before using the product. This should be checked periodically by an adult.
- This product is intended for outdoor use only.
- Do not carry out alterations or modifications to this product.
- This product is not a toy, and is only to be used for its designated purpose.
- Clean only with a damp cloth. Do not use strong industrial cleaning substances.
- To achieve best results, choose a place in maximum light.
- In order to avoid damage to the product, do not place under overhanging trees.
- Avoid placing in areas that are exposed to strong winds.
- Only use this product on stable, level and dry ground.
- Keep fingers, loose clothing, and hair away when folding the lid. Pinch points can cause personal injury.
- Do not discard any of the packaging until you have checked that you have all of the parts and fittings required.
- Use the correct fixings as indicated. Do not tighten any of the nuts until the unit is completely assembled, then finish by tightening all nuts. All nuts must be tightened before use.
- If the product is damaged or has any defects, please contact cservice@oypla.com

Operating Instructions

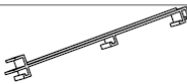
Parts List:

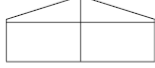
If you are missing any of the below parts please contact cservice@oypla.com

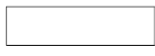
Please be aware that you will be referring to this parts list throughout the assembly

Part No	Quantity	Picture
1	4PCS	
2	4PCS	
3	4PCS	
4	2PCS	
5	2PCS	
6	1PCS	
7	2PCS	
8	2PCS	
9	2PCS	
10	2PCS	

Assembly Instructions

1. Attach the side sheets to the front and rear sheets by sliding the connectors together as shown.
2. Attach the corner and frame braces to the bottom and bottom of the assembled frame.
3. Attach one side of the lid support to the frame using a screw.
4. Attach the lids by sliding the connectors together along the 2 sides of the lid support.
5. Attach the other side of the lid support using the remaining screw.
6. Secure the cold frame into the ground at each corner using the ground stakes.

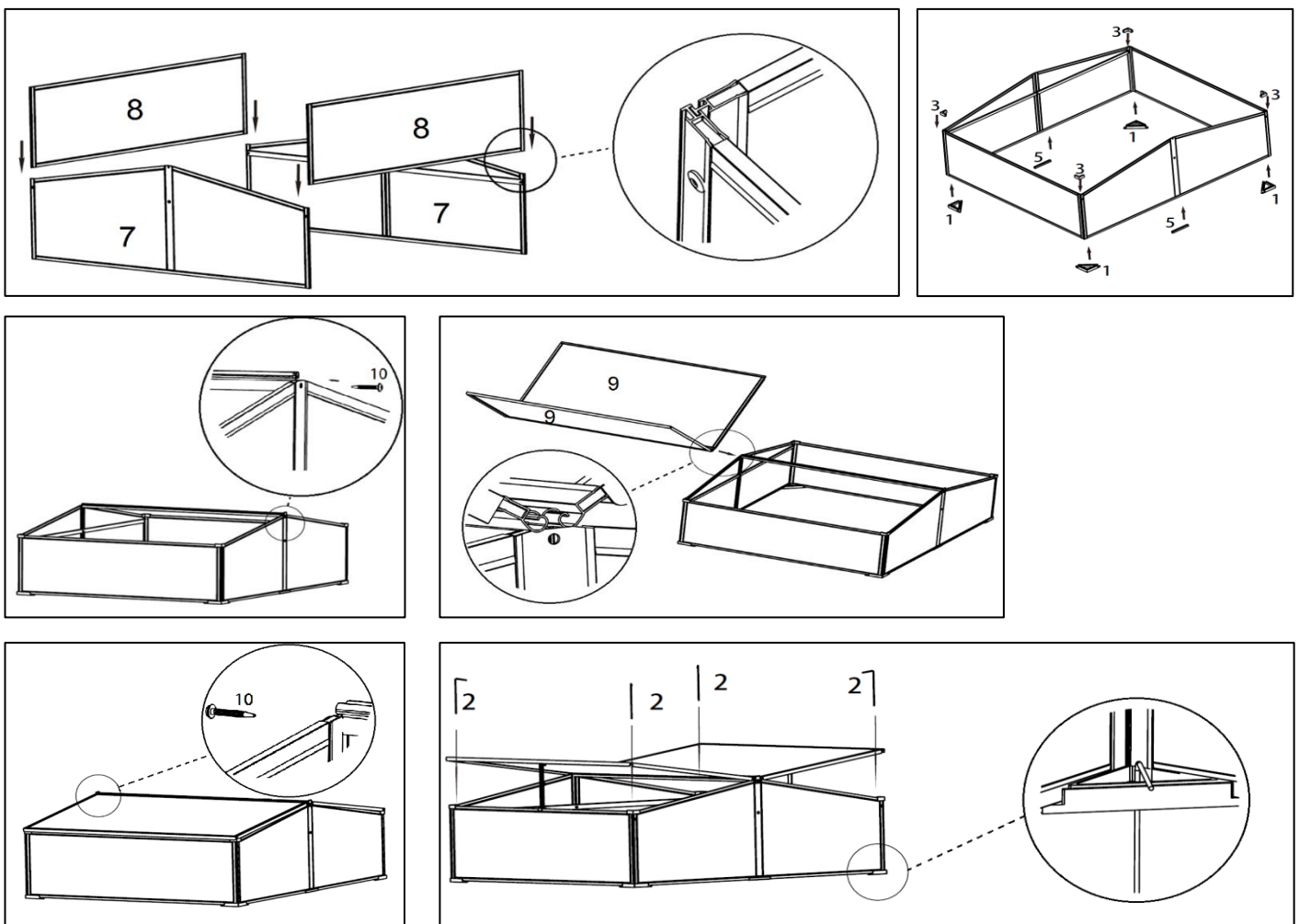

Please retain a copy of all instructions for future consultation.



An Official Oypla Branded Product