

HOME

User Manual

Model Code: 3866

THANK YOU FOR YOUR ORDER

Contents

- 1 Front Cover
-
- 2 Safety
Instructions
-
- 2 Warnings
-
- 3 Assembly
Instructions
-
- 4 Installation
Instructions
-
- 6 Additional
Instructions
-



Stainless Steel Sink

Contents

1	Front Cover
-	-
2	Safety Instructions
-	-
2	Warnings
-	-
3	Assembly Instructions
-	-
4	Installation Instructions
-	-
6	Additional Instructions
-	-
7	Back Cover

End

Safety Instructions

Notice: Ensure you read and fully understand instructions before use

While every attempt is made to ensure the highest degree of protection in all equipment, we cannot guarantee freedom from injury. The user assumes all risk of injury due to use. All merchandise is sold on this condition, which no representative of the company can waive or change.

- Never clean the sink using wire wool and/or abrasive cleaning substances, as these may damage the product.
- Do not expose the sink ware to bleaches containing hypochlorite for extended periods, as this can cause “pitting” in the surface of the stainless steel. Also, a reminder that abrasive cleaners, chemicals used to unblock drains, silver dip cleaner, salt and vinegar should be diluted as quickly as possible and flushed away.
- Do not leave standing water in your sink, especially when it may contain strong staining pigments such as coffee or tea.
- Make sure all fastenings are tightly in place and that everything is in order before using the product. This should be checked periodically by an adult.
- Using metal scouring pads on your sink can not only cause rust and scratches, but can also lead to discolouring on your sink’s surface. Do not use metal scouring pads.
- Avoid placing a rubber mat on your sink bottom. It provides a perfect environment for cultivating harmful bacteria, which can not only cause illness but can also tarnish your sink’s colour and finish.
- This product is intended for indoor use only.
- This product is only to be used for its intended purpose.
- Do not make modifications or alterations to this product.
- If your product is damaged or defective, please contact cservice@oypla.com

Warnings

 Be wary of sharp metal edges during the sink installation process.







 Take extra care when using power tools during the installation process.

Contents

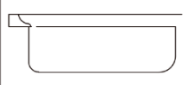
Assembly Instructions

Parts List:

- If you are missing any of the below parts, please contact cservice@oypla.com
- Please be aware that you will be referring to this parts list throughout the assembly process.

Ax1	Bx1	Cx1	Dx1	Ex1	Fx1
					

1 Front Cover
-

2 Safety Instructions
-

2 Warnings
-

3 Assembly Instructions
-

4 Installation Instructions
-

6 Additional Instructions
-

7 Back Cover

End

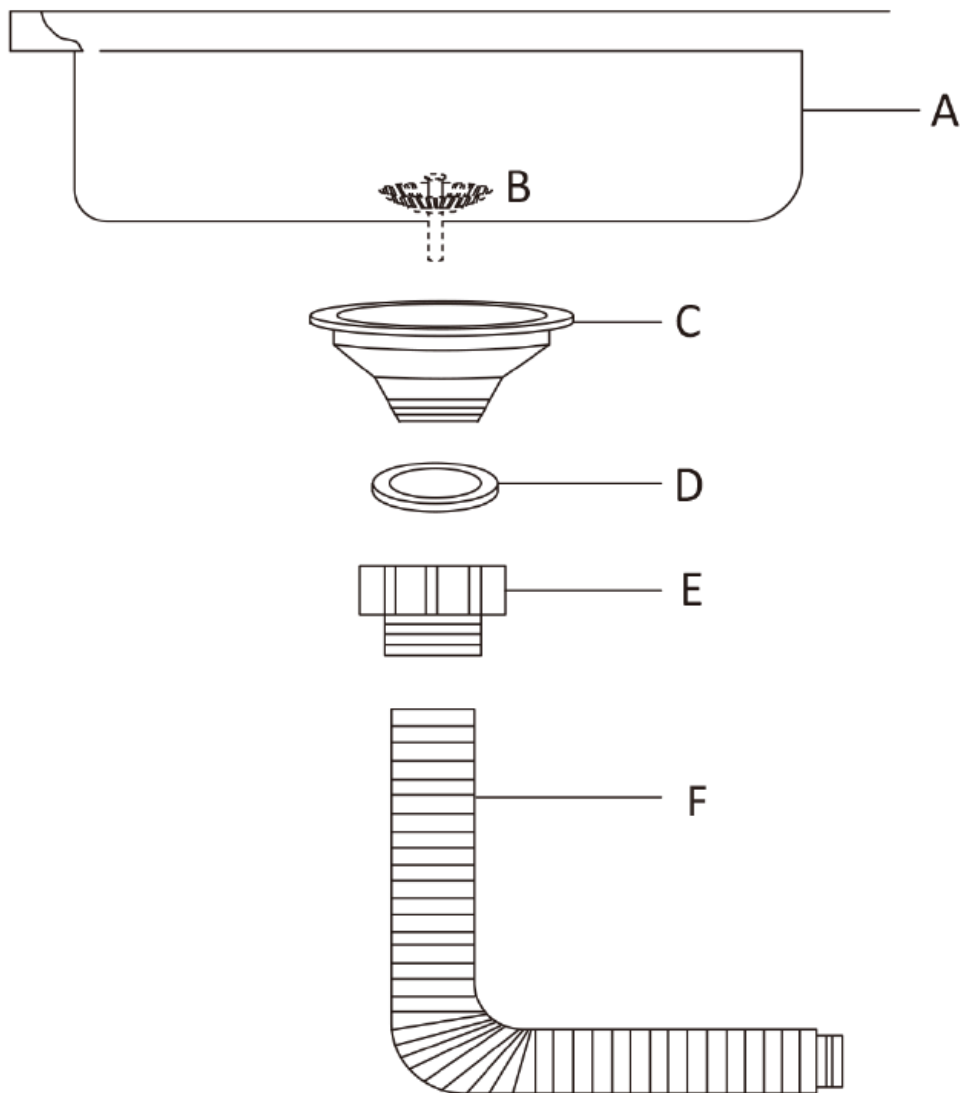

Contents

Installing the Sink

RECOMMENDED TOOLS AND MATERIALS

Most of the procedures require the use of common tools and materials, which are available from hardware and plumbing, supply stores. It is essential that the tools and materials be on hand before work is begun.

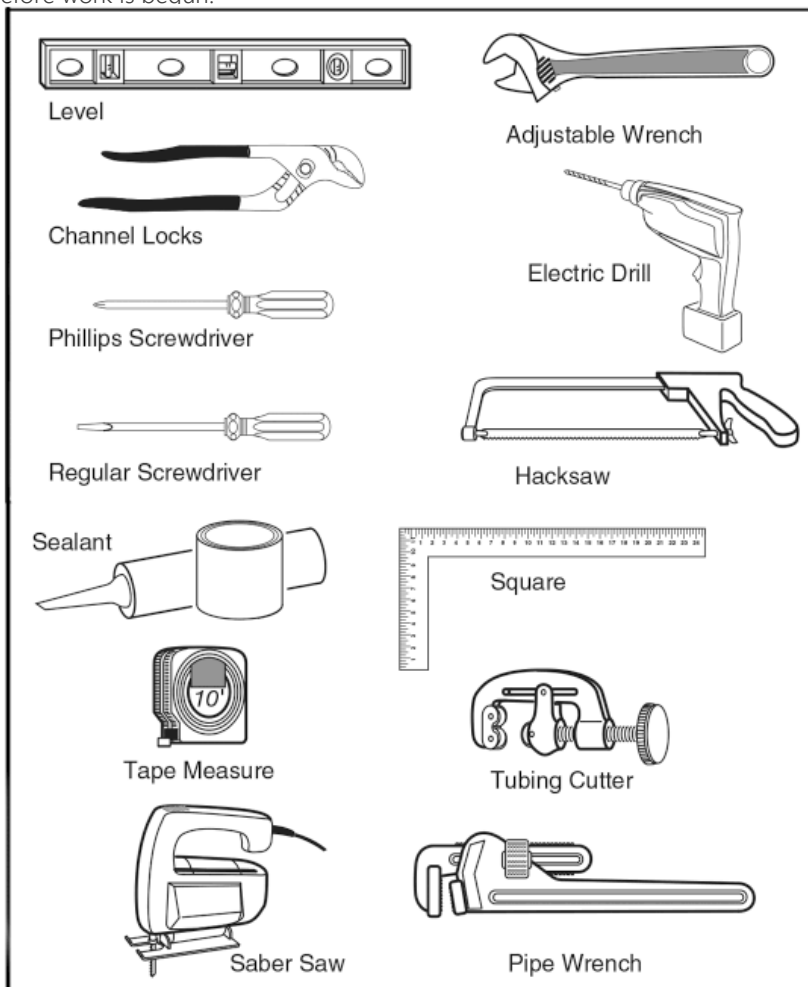

- 1 Front Cover
-
- 2 Safety Instructions
-
- 2 Warnings
-
- 3 Assembly Instructions
-
- 4 Installation Instructions
-
- 6 Additional Instructions
-
- 7 Back Cover

End

Contents

1	Front Cover
-	-
2	Safety Instructions
-	-
2	Warnings
-	-
3	Assembly Instructions
-	-
4	Installation Instructions
-	-
6	Additional Instructions
-	-
7	Back Cover

End

STEP 1 – CREATING A TEMPLATE

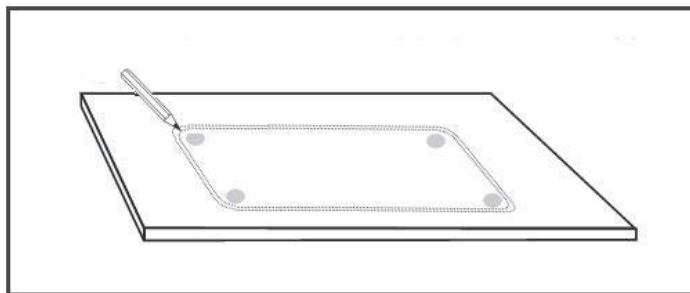

1. Turn the sink upside down on the piece of plywood and draw around it.
2. Cut out the template and place it on the countertop, making sure that the sink front is parallel to the front of the counter. Be sure the sink is properly centred, both front to back and side to side.
3. Check for adequate clearance relative to cabinet walls and pull-out or tilt-down drawers.
4. Tape the template in place and trace the line with a pencil.
5. Accurately mark out a second line 10mm inside the initial bowl outline (to the appropriate measurement, there are many differences in flange dimensions); this will be the

STEP 2 – CREATING SINK CUTOUT

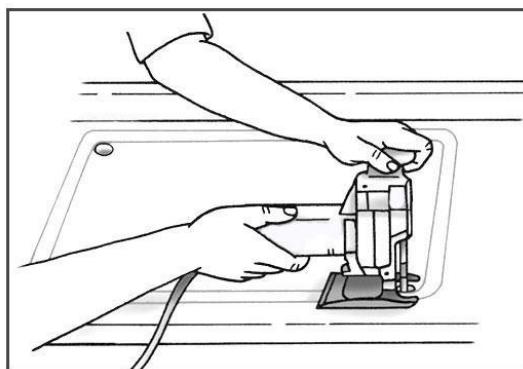

1. Place a brace under the countertop to support the sink cutout area. This will also make it easier to do the sink cutout.
2. Drill a hole inside every corner of the cutout section outlined by the template.
3. Place a strip of masking tape along the inside and outside of each cutout line. The tape protects the countertop surface from scratches while cutting.
4. Insert the saber saw's laminate blade into the pilot hole and cut along the template lines. When you get to the fourth side of the cutout, support the waste panel with your hand to keep the edge countertop from splintering as it falls.

Contents

1	Front Cover
-	-
2	Safety Instructions
-	-
2	Warnings
-	-
3	Assembly Instructions
-	-
4	Installation Instructions
-	-
6	Additional Instructions
-	-
7	Back Cover

End

STEP 3 – INSERTING & CAULKING

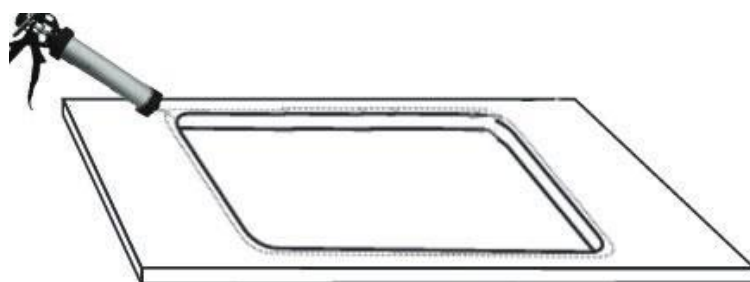

1. Trial fit the sink, by inserting it into the countertop to test whether the cutout is the correct size.
2. Apply a bead of caulk on the surface of the countertop around the edge of the cutout. The caulk forms a watertight seal around the edge of the sink and prevents water damage to the laminate's substrate.
3. Place the sink in the cutout and press it firmly in place to spread the caulk.
4. Wipe away excess caulk on the countertop around the edge of the sink with plastic scraper or laminate strip. then wipe clean and smooth with white spirits and a clean cloth.

Additional Guidance

Please refer to the instructions below in regards to cleaning and maintaining your product.

- After use, the stainless-steel sink ware should be wiped down using:
 - A soft, damp, soapy cloth.
 - A nontoxic all-purpose cleaner.
 - Full-strength distilled white vinegar on a sponge.
- Please take note that hard water can cause a buildup of a grey film on the steel causing a discoloration.
- For sanitation purposes, we recommend regularly disinfecting your sink with a light bleach solution, pre-packaged disinfectant wipes, or other mild anti-bacterial solutions. Ensure that you thoroughly rinse your sink to alleviate any residue or buildup.
- Have your water quality checked. Hard water can cause buildup that can break down the protective surface of your sink and cause rusting.

Contents

- 1 Front Cover
-
- 2 Safety Instructions
-
- 2 Warnings
-
- 3 Assembly Instructions
-
- 4 Installation Instructions
-
- 6 Additional Instructions
-
- 7 Back Cover

End

HAVE A QUESTION ABOUT YOUR PURCHASE?

Our dedicated customer services team are happy to help. Contact them via:

Telephone: 020 3600 22 55
Email: cservice@oypla.com
Live Chat: WWW.OYPLA.COM

CONSIDER THE ENVIRONMENT!

In the United Kingdom, approximately 5 billion corrugated boxes are used per year, amounting to around 83 per person! By recycling the cardboard box in which this product was packed, you contribute to the preservation and sustainability of the environment.

If you see a recycling logo on the packaging of your product, such as the below examples, that piece of packaging is recyclable. If there is not a recycling logo, please check with your local authorities before recycling.



PLEASE RETAIN A COPY OF THESE INSTRUCTIONS FOR FUTURE CONSULTATION

OYPLA.COM

AN OFFICIAL OYPLA BRANDED PRODUCT