



# **Bistro Table**

USER MANUAL Model No: 3823

# Safety Instructions

**Notice: Ensure you read and fully understand instructions before use**

While every attempt is made to ensure the highest degree of protection in all equipment, we cannot guarantee freedom from injury. The user assumes all risk of injury due to use. All merchandise is sold on this condition, which no representative of the company can waive or change.















- This product contains small parts that could be a choking hazard if swallowed. Keep these items away from children.
- Make sure all fastenings are tightly in place and that everything is in order before using the product. This should be checked periodically by an adult.
- Never exceed the maximum load capacity of **30kg**, or it may result in product failure and/or personal injury.
- This product is not a toy, and is only to be used for its designated purpose.
- Do not carry out alterations or modifications to this product.
- Clean only with a damp cloth. Do not use strong industrial cleaning substances.
- Leaving the product outside exposed to weather, especially direct sun and rain, will speed the weathering process. This can be slowed by removing the product from these conditions, or covering it with a suitable cover.
- Only use this product on stable, level and dry ground.
- Do not sit on the table.
- If the product is damaged or has any defects, please contact [cservice@oypla.com](mailto:cservice@oypla.com)

# Operating Instructions

## Parts List:

If you are missing any of the below parts please contact [cservice@oypla.com](mailto:cservice@oypla.com)

Please be aware that you will be referring to this parts list throughout the assembly process.

A 		B 		C 	D 	E 	F 
1PC		1PC		1PC	1PC	3PCS	1PC
G 	H 	I 	J 	K 	L 	M 	N 
1PC	1PC	1PC	3PCS	1PC	4PCS	4PCS	1PC

## Step 1: Putting together the table top

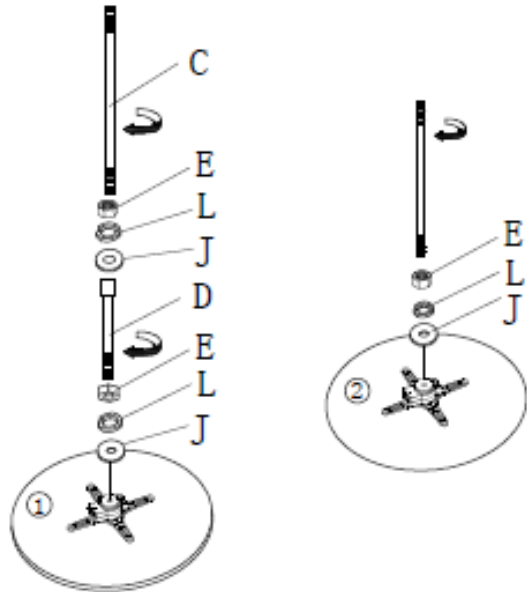
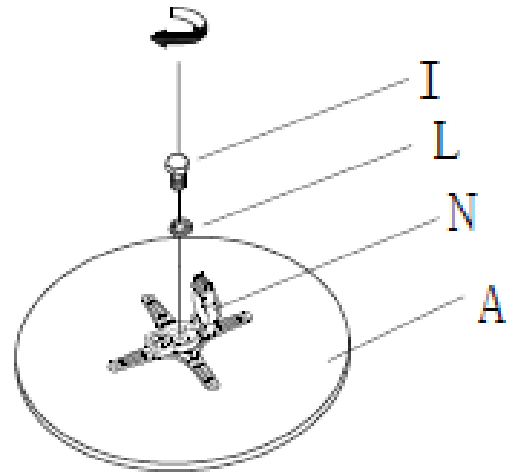

## Step 2: Building the frame of the table

## Step 3: Attaching the base and wheels

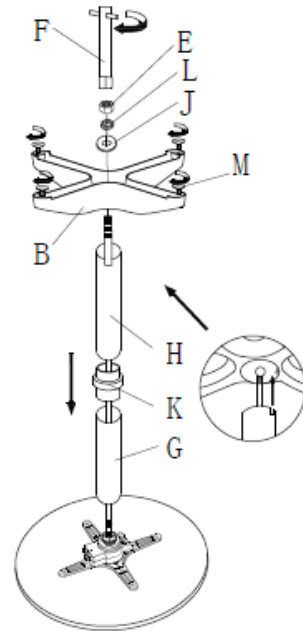

### **HAVE A QUESTION ABOUT YOUR PURCHASE?**

OUR DEDICATED CUSTOMER SERVICES TEAM ARE HAPPY TO HELP  
CONTACT THEM VIA:

TELEPHONE: 020 3600 2255

EMAIL: [cservice@oypla.com](mailto:cservice@oypla.com)

LIVE CHAT: [www.oypla.com](http://www.oypla.com)

PLEASE RETAIN A COPY OF THESE INSTRUCTIONS FOR FUTURE CONSULTATION

# OYPLA.COM

An Official OYPLA Branded Product

Imported by Oypla.com LLP, Uxbridge, UB8 2FX

**USER MANUAL Model No: 3823**