



Double Canvas Wardrobe

Safety Instructions

Notice: Ensure you read and fully understand instructions before use

While every attempt is made to ensure the highest degree of protection in all equipment, we cannot guarantee freedom from injury. The user assumes all risk of injury due to use. All merchandise is sold on this condition, which no representative of the company can waive or change.









- This product is not a toy and should only be used for its designated purpose.
- Make sure that the frame is secure before applying any weight to the product.
- This product is intended for indoor use only.
- Do not carry out alterations or modifications to this product.
- Do not discard any of the packaging until you have checked that you have all the parts and fittings required.
- When placing shoes in the wardrobe, ensure that there are no sharp edges or rough edges that will cause the canvas platforms to become torn and broken.
- Overloading the wardrobe can result in product failure or damage.
- Clean only with a damp cloth. Do not use strong industrial cleaning substances or abrasive materials as these will damage the product.
- If the product is damaged or has any defects, please contact cservice@oypla.com

Assembly Instructions

Parts List:

If you are missing any of the below parts please contact cservice@oypla.com

Please be aware that you will be referring to this parts list throughout the assembly process.

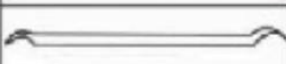
Number	Cutline	Qty
(A)		20
(B)		4
(C)		2
(D)		2
(E)		2
(1)		4
(2)		4
(3)		32
(4)		15
(7)		1

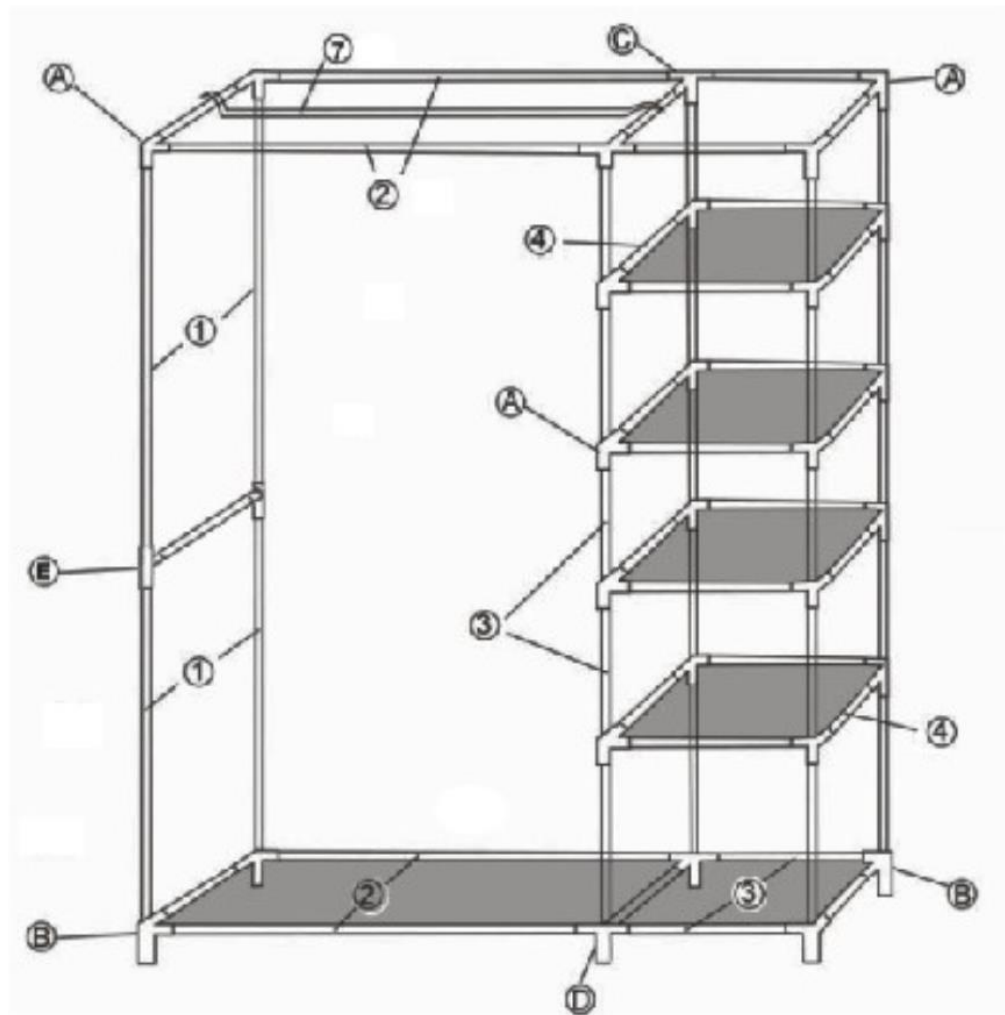

Please retain a copy of all instructions for future consultation.



An Official Oypla Branded Product

Imported into the EU by Oypla.com LLP, Uxbridge, UB8 2FX

USER MANUAL Model No: 3658