

# Garment Clothes Rail

# Safety Instructions

**Notice: Ensure you read and fully understand instructions before use**





**While every attempt is made to ensure the highest degree of protection in all equipment, we cannot guarantee freedom from injury. The user assumes all risk of injury due to use. All merchandise is sold on this condition, which no representative of the company can waive or change.**

- This product contains small parts that could be a choking hazard if swallowed. Keep these items away from children.
- If at any time during activity, you feel faint, dizzy or experience pain, stop and consult your physician or doctor.
- Make sure all fastenings are tightly in place and that everything is in order before using the product. This should be checked periodically by an adult.
- This product is not a toy, and is only to be used for its designated purpose.
- Clean only with a damp cloth. Do not use strong industrial cleaning substances.
- Leaving the product outside exposed to weather, especially direct sun and rain, will speed the weathering process. This can be slowed by removing the product from these conditions.
- Children should not use this product at any time.
- Do not over load the product at any one time.
- Weight capacity 100KG.
- An adult should only assemble the garment rail.
- Never swing or hang on the garment rail.
- Only use this product on a stable, level and dry ground.
- If any parts are missing or damaged, please contact [cservice@oypla.com](mailto:cservice@oypla.com)

# Parts List

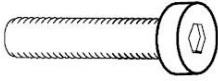
If you are missing any of the below parts please contact [cservice@oypla.com](mailto:cservice@oypla.com)

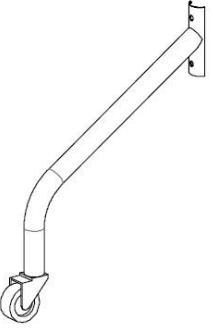
Please be aware that you will be referring to this parts list throughout the assembly process.

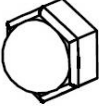
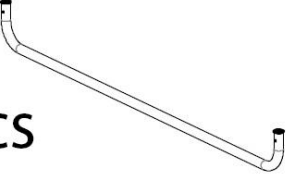
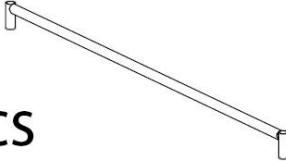
<b>A</b> M6x30mm  2pcs	<b>B</b> M6x40mm  4pcs	<b>E</b> 2pcs 	<b>H</b>  1pcs
<b>C</b>  6pcs	<b>D</b>  6pcs	<b>F</b> 1pcs 	
		<b>G</b> 1pcs 	

# Assembly Instructions

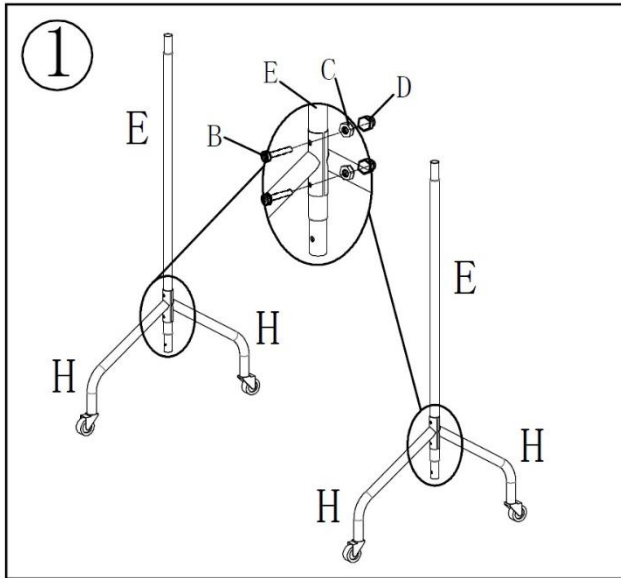

1. Begin by taking parts E and Hx2pcs. Align part E and Hx2pcs up together making sure the screw holes align. Use screw Bx2, nuts Cx2 and nut cover Dx2 to secure the legs to the frame. DO NOT over tighten. Repeat this process once more.

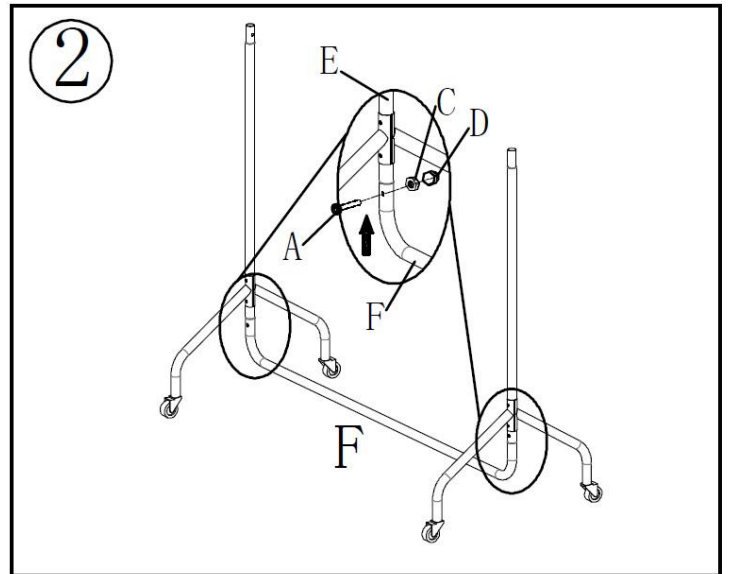

2. Take part F and slide onto the two supporting legs you created in step one. Use screws Ax2pcs, nuts Cx2pcs and nut cover Dx2pcs to secure the bottom rail in place. Please see image above.

**Please retain a copy of all instructions for future consultation**



**An Official Oypla Branded Product**

