

GARDEN

THANK YOU FOR YOUR ORDER

Contents

- 1 Front Cover
-
- 2 Safety
Instructions
-
- 2 Warning
Instructions
-
- 3 Assembly
Instructions
-
- 4 Assembly
Instructions
-
- 5 Back Cover

End

OYPLA



Wooden Cold Frame House

Contents

1	Front Cover
-	-
2	Safety Instructions
-	-
2	Warning Instructions
-	-
3	Assembly Instructions
-	-
4	Assembly Instructions
-	-
5	Back Cover

End

Safety Instructions

Notice: Ensure you read and fully understand instructions before use

While every attempt is made to ensure the highest degree of protection in all equipment, we cannot guarantee freedom from injury. The user assumes all risk of injury due to use. All merchandise is sold on this condition, which no representative of the company can waive or change.

- This product contains small parts that could be a choking hazard if swallowed. Keep these items away from children.
- Make sure all fastenings are tightly in place and that everything is in order before using the product. This should be checked periodically by an adult.
- Do not carry out alterations or modifications to this product.
- Clean only with a damp cloth. Do not use strong industrial cleaning substances or abrasive materials.
- Do not discard any of the packaging until you have checked that you have all of the parts and fittings required.
- Keep away from fire.
- If product is damaged or has any defects, please contact cservice@oypla.com
- This product is intended for outdoor use only.
- This product is not a toy, and is only to be used for its designated purpose.
- Leaving the product exposed to weather, especially direct sun and rain, will speed the weathering process. This can be slowed by removing the product from these conditions.
- Keep fingers, loose clothing, hair and jewellery away when assembling the product. Pinch points can cause injury.
- Use the correct fixings as indicated. Do not tighten any of the nuts until the unit is completely assembled, then finish by tightening all the nuts. All nuts must be tightened before use.

Warnings

 This product contains small parts that could be a choking hazard if swallowed. Keep these away from children!

 Watch for pinch points! Keep fingers, loose clothing, hair and jewellery away during assembly of the product. Pinch points can cause personal injury.

Contents







1	Front Cover
-	
2	Safety Instructions
-	
2	Warning Instructions
-	
3	Assembly Instructions
-	
4	Assembly Instructions
-	
5	Back Cover

End

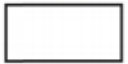
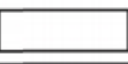
Assembly Instructions

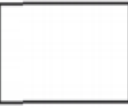
Parts List:

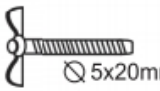
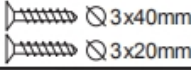
- If you are missing any of the below parts, please contact cservice@oypla.com
- Please be aware that you will be referring to this parts list throughout the assembly process.

A	Back Panel		1
B	Front Panel		1
C1	Side Panel Left		1
C2	Side Panel Right		1
D	Lid Panel & Hinges		2
E	Lid Support Arms		2
F	Wing Bolt	 Ø 5x20mm	2
H	Large Screws	 Ø 3x40mm Ø 3x20mm	8 2
I	Small Screws	 Ø 2.5x10mm	4

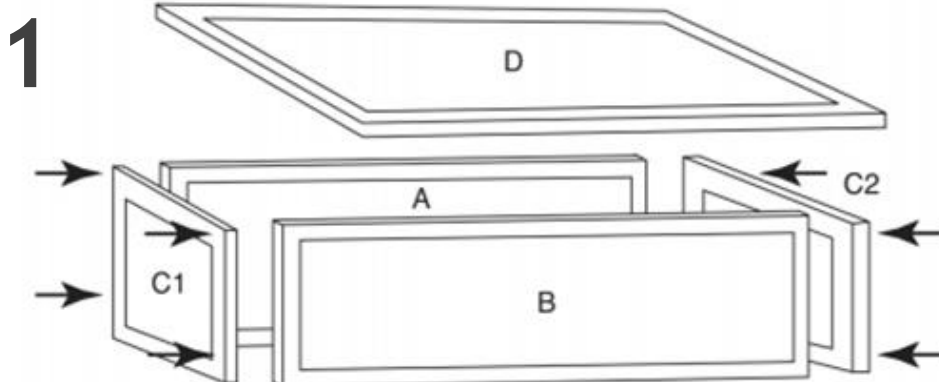

Assemble the back, front and side frames (**A, B, C1, C2**) using the **H** screws provided (**8 X 3x40mm**). Please see the diagram above to help you.

Contents

- 1 Front Cover
-
- 2 Safety Instructions
-
- 2 Warning Instructions
-
- 3 Assembly Instructions
-
- 4 Assembly Instructions
-
- 5 Back Cover
- End

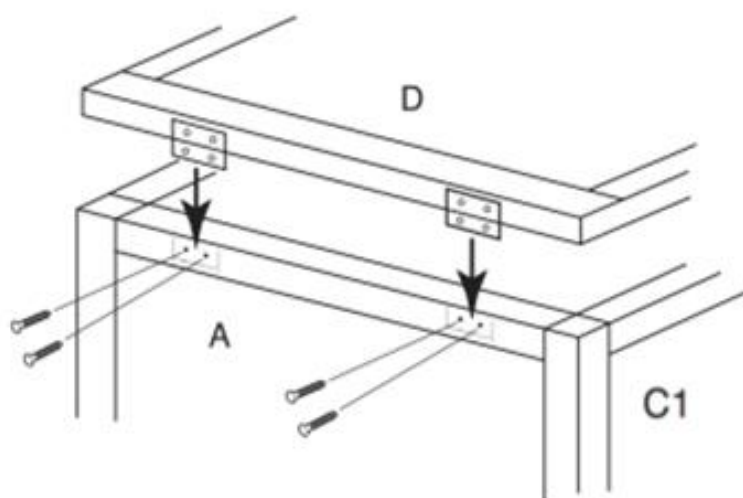
2

Next assemble the roof/lid panel (**D**) to the frame built in step 1. Ensuring the hinges (**D**) attach to the back panel (**A**). Secure these in place with part **I** screws (**4 X 2.5x10mm**). Please see the diagram above to help you.

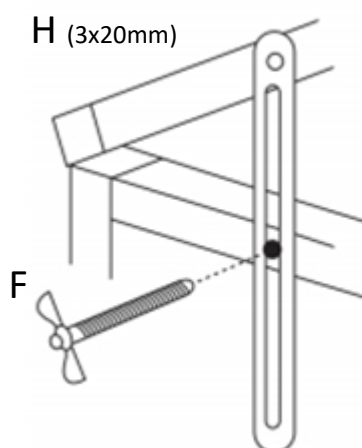
3

Lastly, attach the lid support arms (**E**) to either side panel (**C1, C2**) by using the large **H** screws (**2 X 3x20mm**) which are left. Secure these into the lid panel (**D**), before using the wing nuts to fully attach the support arm (**E**) to the frame. Again, please see the diagram above for guidance if required.

Contents

1	Front Cover
-	-
2	Safety Instructions
-	-
2	Warning Instructions
-	-
3	Assembly Instructions
-	-
4	Assembly Instructions
-	-
5	Back Cover
	End

HAVE A QUESTION ABOUT YOUR PURCHASE?

Our dedicated customer services team are happy to help. Contact them via:

Telephone: 020 3600 22 55
Email: cservice@oypla.com
Live Chat: WWW.OYPLA.COM

CONSIDER THE ENVIRONMENT!

In the United Kingdom, approximately 5 billion corrugated boxes are used per year, amounting to around 83 per person! By recycling the cardboard box in which this product was packed, you contribute to the preservation and sustainability of the environment.

If you see a recycling logo on the packaging of your product, such as the below examples, that piece of packaging is recyclable. If there is not a recycling logo, please check with your local authorities before recycling.



PLEASE RETAIN A COPY OF THESE INSTRUCTIONS FOR FUTURE CONSULTATION

OYPLA.COM

AN OFFICIAL OYPLA BRANDED PRODUCT